

Product Overview

Motor Driven Reels



CONDUCTIX
wampfler

DELACHAUX GROUP



909

20'

45' 40''

909

20'

40' 45''

AMF-KOCC

seaco

VICTORY

10



An all round solution for cable and hose management

Where ever goods and people are in motion, you will find custom-engineered motor driven reels designed and built by Conductix-Wampfler. If you need to manage critical power cables, data cables, air hoses, or fluid hoses, we have the ideal solutions!

Our many years of experience in developing and manufacturing motorized reeling systems have resulted in a sophisticated and highly developed product line.

For the management of low voltage and high voltage cables or hoses, Conductix-Wampfler motor driven reels cater to all kinds of applications.

Reliability cannot be compromised. Conductix-Wampfler reels safely handle cables for critical applications.

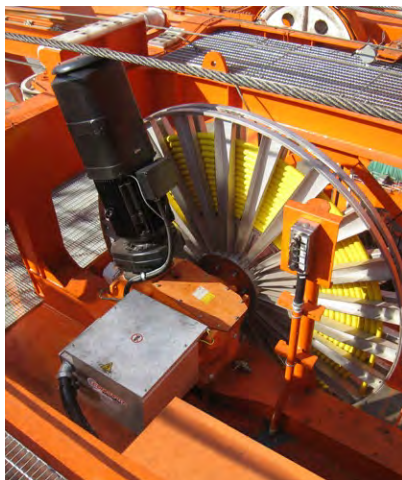

At container and bulk ports, steel mills, theaters, waste water treatment plants, and mines, Conductix-Wampfler motorized reels reliably handle demanding requirements, even in harsh environmental conditions.

Installation on-site can be completed quickly and periodic maintenance is fast and easy. During their lifetime, Conductix-Wampfler motor driven reels will minimize your total cost of ownership.

Conductix-Wampfler offers a complete package of services to our customers. In addition to the delivery of the motorized reel, we offer qualified project consulting, complete system engineering services, selection of the right cable, and a full array of accessories.

Management of project logistics and on-site commissioning are important services we provide for our customers.

Thus, energy and data signals reach your machinery safely and reliably, wherever they are required.

Conductix-Wampfler provides service before and after the sale from our global network of sales offices. We support you - worldwide!



24/7 operation in demanding environments such as bulk material handling

Everything from one source!
The right cable is always recommended.



Component Description

Motor Driven Reel

- 1 Cable or hose
- 2 Spool
- 3 Gearbox
- 4 Drive unit
- 5 Rotary joint in housing
- 6 Limit switch
- 7 Diverter
- 8 Rollerbox
- 9 Cable guide

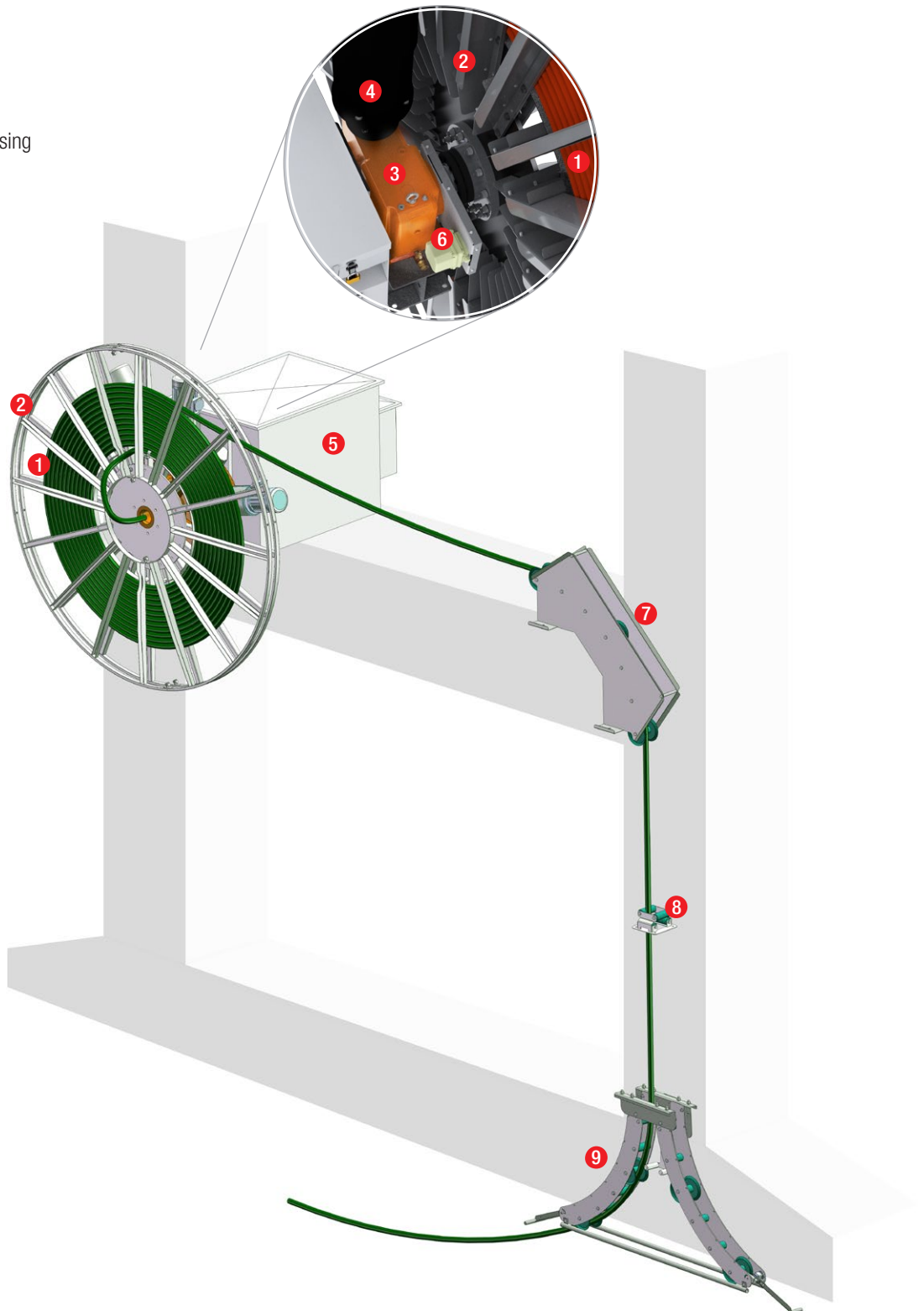

Typical Reel Parameters

What are your requirements?

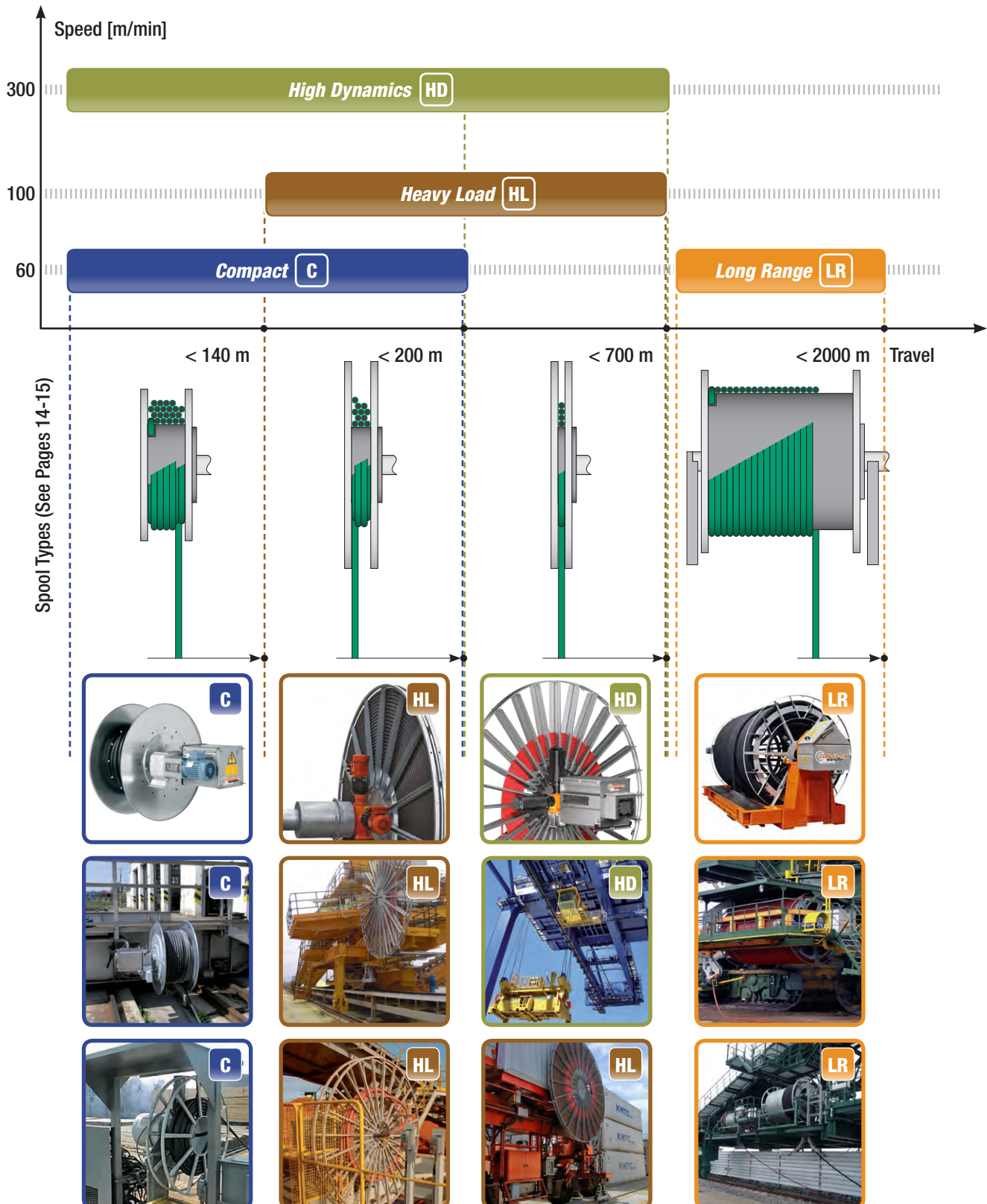

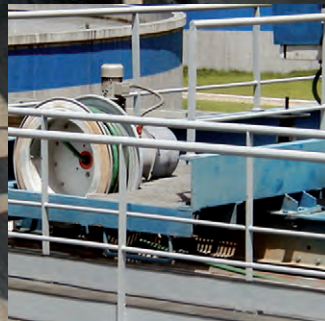

Series **C** | Compact

Typical applications

- Gantry cranes
- Overhead cranes
- Grabs or magnets
- Transfer cars
- Waste water treatment facilities
- Theater stage rigging



Optimal corrosion protection even in tough environments.

Flanges and reel drum are manufactured from hot dip galvanized steel.

Reliable operation with standardized slip ring assembly.

Highly durable, maintenance-free and contactless torque transmission - standard motor with magnetic coupler.

Specifications

Travel speed	Up to 100 m/min
Winding length	200 m max
OD of spool	Random wind spool: 400 mm – 1700 mm Monospiral spool or 3-2-3 spool: 1100 mm – 3600 mm
Gearbox	W: 100 N m – 400 N m BNA: 300 N m – 700 N m
Slip ring assembly <small>(Also available with rotary joint for hose installation)</small>	Power max: 690 V – 200 A Control 690 V – 25 A Data: Ethernet 100 Mbps – 1 Gbps
Temperature range	-30 °C – +60 °C

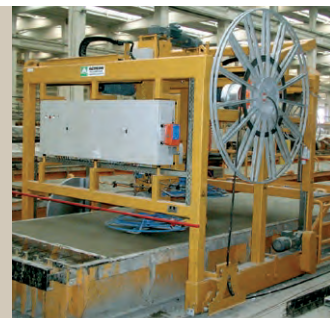
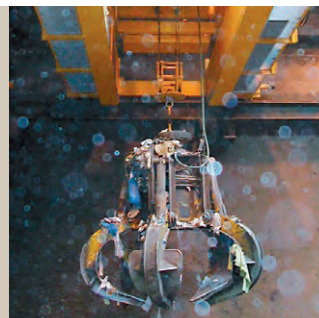
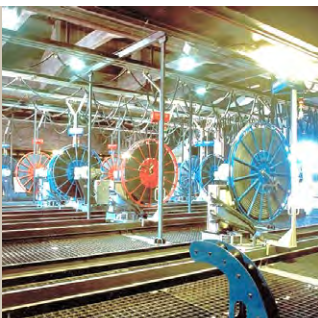



Series **HL** | Heavy Load

Typical applications

- Ship-to-shore (STS) cranes
- Rail mounted gantry (RMG) cranes
- Ship unloaders
- Stackers / reclaimers
- Shipbuilding cranes

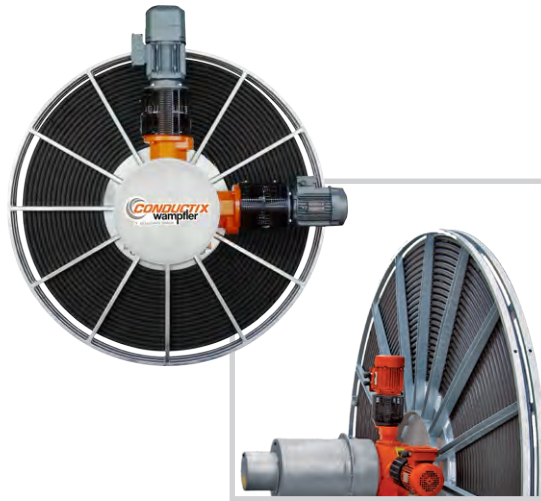

Modular assembly system

The cable reel can be upgraded after installation by adding drive units.

Magnetic Coupler Drive (MAG Drive) or Variable Frequency Drive (SMART Drive)

5 year or 15,000 hour operation before any maintenance is required

Gearboxes are grease-lubricated from the factory.

Optimal corrosion protection to handle aggressive environments

Flanges and reel drum are manufactured from hot dip galvanized steel or stainless steel.

Specifications

Travel speed	MAG Drive: up to 100 m/min SMART Drive: up to 180 m/min with Active Control Unit up to 50 m/min with Core Control Unit
Winding length	700 m max
OD of spool	Monospiral spool or 3-2-3 spool*: 1100 mm – 8000 mm
Gearbox	BNA: 1100 N m – 16000 N m HD: 3400 N m – 6500 N m KHD: 2400 N m – 10000 N m
Slip ring assembly <small>(Also available with rotary joint for hose installation)</small>	Power low voltage max: 690 V – 1600 A Power high voltage max: 24000 V – 500 A Control max: 500 V – 25 A Data: Ethernet 100 Mbps – 1 Gbps Fiber optic Multimode – Single Mode
Temperature range	-40 °C – +60 °C

* See page 14 for further description of a 3-2-3 spool



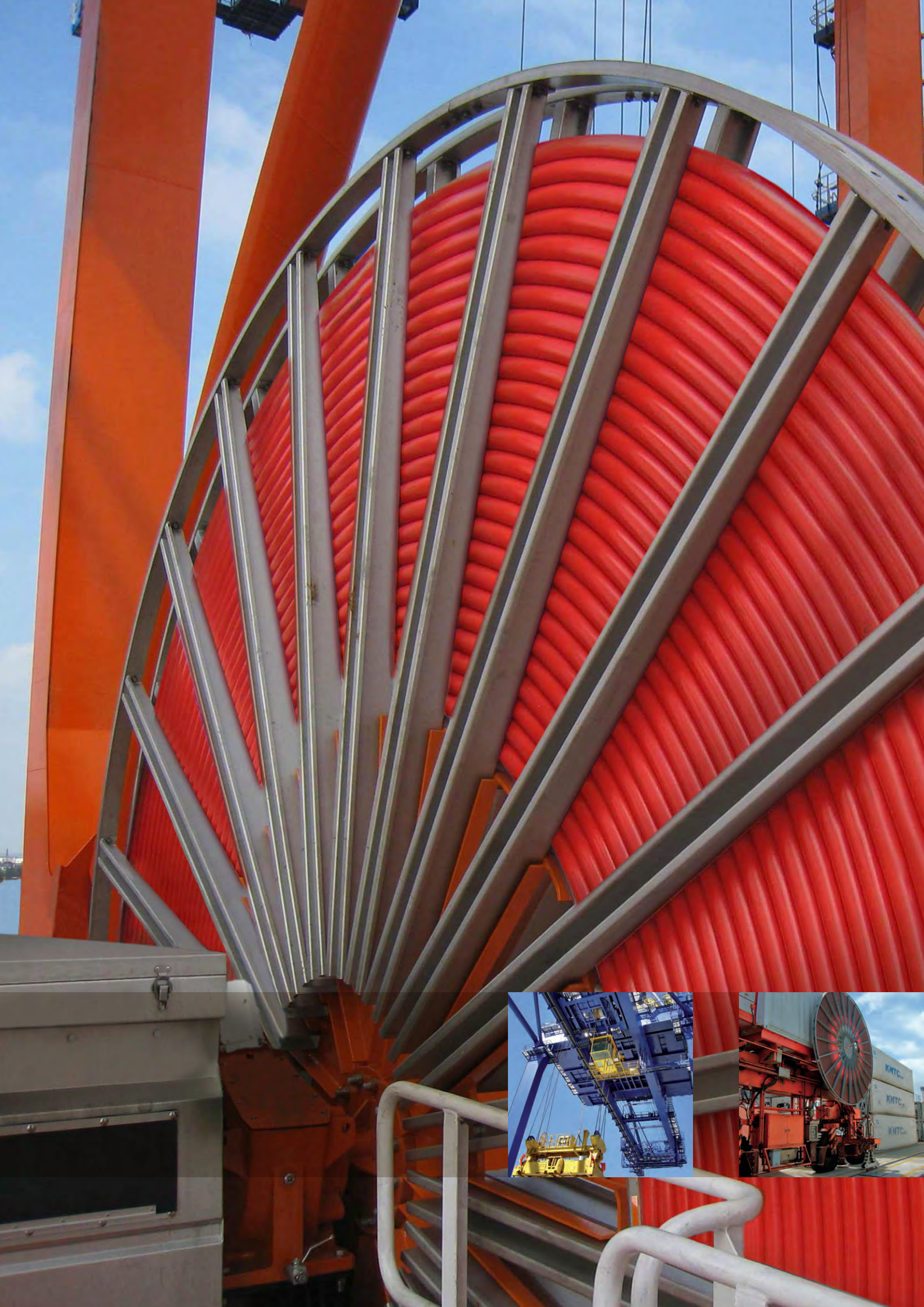

Series **HD** | *High Dynamics*

Typical applications

- Spreader reels
- Ship-to-shore (STS) cranes
- Automated stacking cranes
- Rail mounted gantry (RMG) cranes
- Electric rubber tyred gantry (E-RTG) cranes
- Intermodal cranes
- Automated RTG (ARTG) cranes

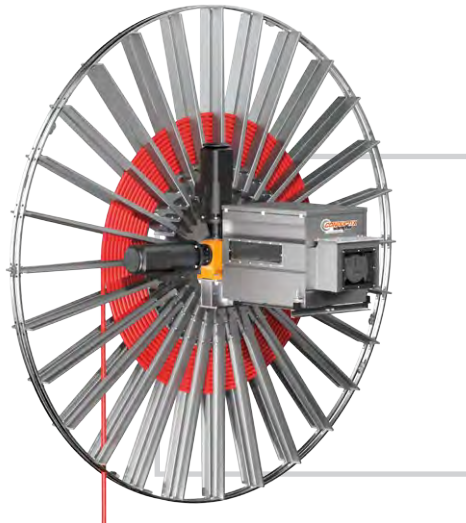

Sophisticated speed and torque control are ideal for machines with highly dynamic operation.

Highly efficient components and low starting inertia.

Smooth handling of cable increases cable lifetime and overall system reliability.

Optimal corrosion protection even under aggressive conditions
Flanges and reel drum are manufactured from hot dip galvanized steel or stainless steel.

Specifications

Travel speed	MAG Drive: up to 150 m/min SMART Drive: up to 300 m/min
Winding length	700 m max
OD of spool	Monospiral spool: 1100 mm – 8000 mm
Gearbox	BNA: 1100 N m – 10000 N m KHD: 2400 N m – 10000 N m
Slip ring assembly	Power low voltage max: 690 V – 1600 A Power high voltage max: 24000 V – 500 A Control max: 500 V – 25 A Data: Ethernet 100 Mbps – 1 Gbps Fiber optic Multimode – Single Mode
Temperature range	-40 °C – +60 °C

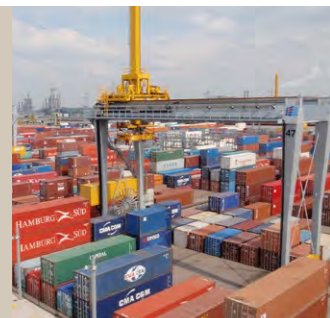



Series **LR** | Long Range

Typical applications

- Stackers / reclaimers
- Bucket wheel excavators
- Tripper cars
- Mobile conveyors
- Scrapers
- Stack rakes



Extra long travel distance

Single or multi-layer drum type spool.

Skeleton-type drum

for optimal cable cooling and reduced inertia.

Modular platform construction

allows multiple arrangements and best fit with machine structure.

Rugged construction

for harsh environments.

Specifications

Travel speed	Up to 60 m/min
Winding length	2000 m max
OD of drum	Up to 3.3 m
Gearbox	BNA: 1000 N m – 18000 N m SMART Drive: 1000 N m – 8500 N m
Slip ring assembly <small>(Also available with rotary joint for hose installation)</small>	Power low voltage max: 690 V – 1600 A Power high voltage max: 36000 V – 500 A Control max: 500 V – 25 A Data: Ethernet 100 Mbps – 1 Gbps Fiber optic Multimode – Single Mode
Temperature range	-40 °C – +60 °C





Spools

The spool is one of the most critical components of a motor driven reel system. Choosing the ideal spool will optimize performance and maximize the life of the cable. The right spool can increase maintenance cycles and avoid downtime.

With either a standard or a customized solution, Conductix-Wampfler is always able to provide the best type of spool for your application.

• Random Wind Spools

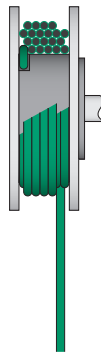

• 3-2-3 Spools

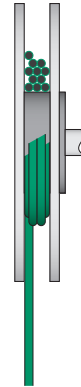

The **Random Wind Spool** is particularly suited for short or medium lengths of cable or hose.

During winding, the cable is naturally distributed around the drum without any cable guide system.

3-2-3 Spools are a combination of Monospiral and Random Wind Spools, where the cable is stacked in layers, each three cable diameters wide.

The 3-2-3 spool is generally used when space available for the spool is limited.



Double Monospiral Spool, with two identical cables with large cross-sections.

Level Wind Spool
with power cable on
a stacker / reclaimer

• Monospiral Spools



The **Monospiral Spool** wraps the cable in the same plane and prevents the cable from twisting. It is your guarantee of a longer cable life.

Monospiral Spools offer maximum exposure to ambient air and best cooling of the cable.

The largest Monospiral Spools can accommodate up to 700 meters of cable.

• Level Wind Spool

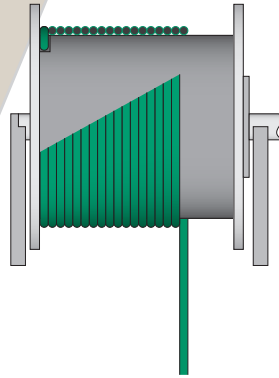

Level Wind Spools are designed to accommodate cables that are 1,000 meters or longer.

The cable is wound in one, two, or three layers on a cylindrical drum. The cable is layered with a guide system driven by the reel drum.

• Special Spools



By request, Conductix-Wampfler can build **Special Spools** such as:

- Double monospiral spools
- Plain monospiral spools
- Spools with alternate materials such as stainless steel
- Spools with special protection and/or dimensions
- Spools with reinforced construction for harsh applications.

Gearbox Units



The gearbox unit supports all reel components and matches the rotational speed and torque to the application.

Conductix-Wampfler gearboxes for compact applications: Type W

This compact gearbox unit is easy to install and can handle low to medium torque requirements. The W-gearbox is available in three different sizes.



Type W gearboxes provide torque values from 100 N m up to 800 N m and each is mounted inside a corrosion resistant aluminum housing. The drive unit and slip ring assembly are parallel to the hollow shaft, allowing compact dimensions.

Conductix Wampfler gearboxes for heavy loads: Type BNA

These bevel gear units are designed for medium to high torque requirements and demanding conditions, providing maximum service.



BNA gearboxes provide torque values from 1100 N m up to 19000 N m. The high dimensional stability of the cast iron housing provides long operational life even when subjected to high mechanical and dynamic stress. Gearboxes are lubricated for a 5-year life span or 15000 operating hours.

Conductix-Wampfler highly dynamic gearboxes: Type KHD

Designed for today's fastest and most dynamic applications that have high torque requirements and extreme dynamic stresses.

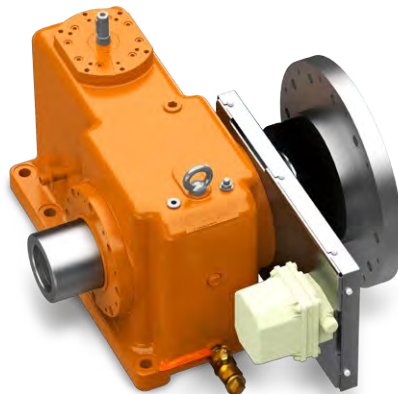

Type KHD gearboxes provide torque from 2400 N m up to 10000 N m. The robust spur gear design withstands abrupt speed changes and load variations while transferring the high power required.

Rotary Joints

Slip Ring Assemblies

Conductix-Wampfler has decades of experience in the design and manufacture of slip ring assemblies.

Our slip ring assemblies comply with IEC, UL, NEMA, and VDE international standards among others. Conductix-Wampfler slip ring assemblies are designed for the following applications:

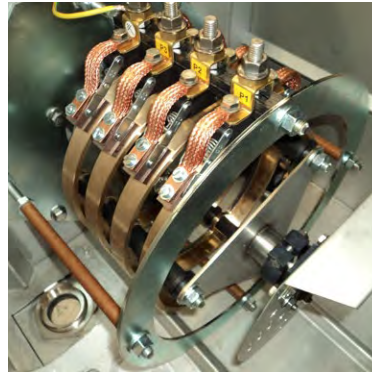
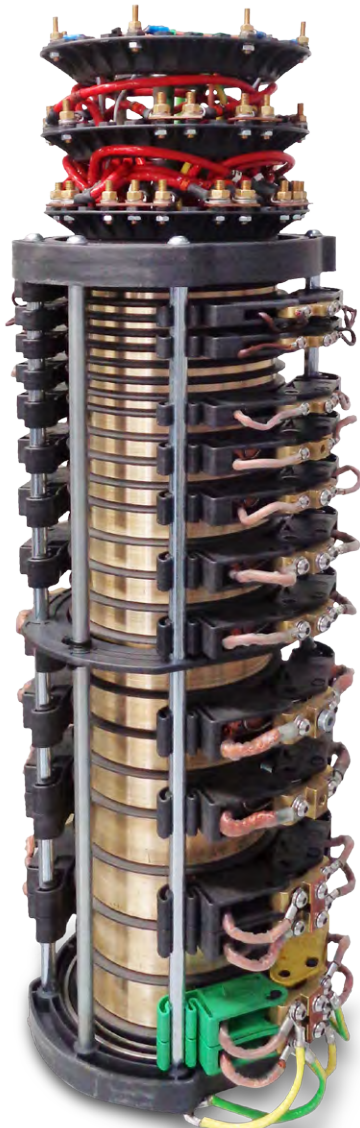

Power

- Low voltage up to 690 V and 1250 A
- High voltage up to 36,000 V and 500 A
- 100% duty cycle

Control + Data

- Low voltage up to 690 V and 25 A
- Data transmission from controls and measurement devices, as well as from, computer, audio-video, and telecom equipment.
- 100% duty cycle

Mixed Construction

- Mixed power and control slip ring assemblies
- Rings of the same or different diameters on the same assembly

Rotary Joint (for hose reels)

For the transfer of air, gases, or fluids, motorized reels can be equipped with a single or multi-channel rotary joint.

- Available pipe thread diameters: $\frac{3}{8}$ " - $\frac{1}{2}$ " - $\frac{3}{4}$ " - 1" - $1\frac{1}{4}$ " - $1\frac{1}{2}$ " - 2" - $2\frac{1}{2}$ " - 3"
- The rotary joints have a standard Kanigen® (electroless nickel) plating.

Fiber Optic Transmitter (TFO)

Conductix-Wampfler was one of the first cable reel manufacturers to develop a fiber optic transmitter that could meet industrial requirements.

Fiber optic cables are ideal for transmitting large amounts of information over long distances.



- Optic fibers: single-mode (9/125) or multi-mode (50/125 and 62.5/125)
- Attenuation: single-mode: < 1.5 dB multi-mode: < 1.0 dB
- Available in models that provide 40, 80, or 120 turns and 6, 12, 18, or 24 fibers
- Standard connectors are type ST (types FC, SC and others available by request)



Rotary joint for hose reel

Drives - Magnetic | MAG Drive

Standard motor with Conductix-Wampfler magnetic coupler

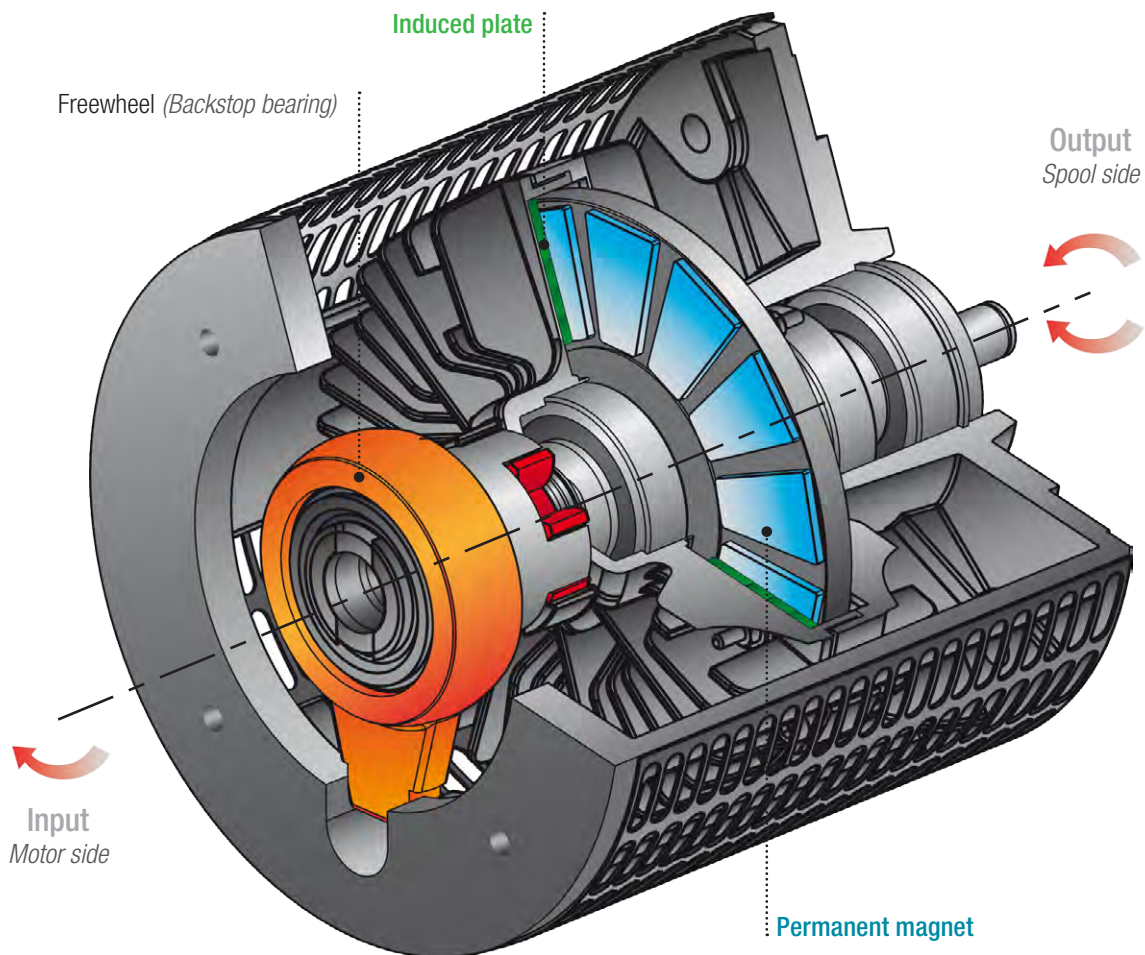

Advantages of Conductix-Wampfler MAG Drive

- Optimized design for maximum magnetic hysteresis :
 - High efficiency and low energy consumption
 - Smooth constant torque to ensure long cable life
- No contact: no friction, no oil, no maintenance
- No loss of cable tension during power failures
- Rugged built with high durability materials
- Most reliable magnetic coupler on the market

Environmental and Operating Considerations

- The Conductix-Wampfler magnetic coupler is completely sealed water and dust proof
- Operates in any position
- Suitable for seaside conditions and exposure to sea waves
- Suitable for hazardous environments (up to AtEx 22)
- Works in ambient temperatures from -40°C up to +70°C



Design

Each Conductix-Wampfler magnetic coupler is assembled from key carefully matched components:

The induced plate is machined from a special hardened magnetic steel ring. Its specific design maximizes the Conductix-Wampfler magnetic coupler yield and reduces energy consumption.

The permanent magnet plate features very high magnetic strength TiCoNiAl magnets mounted with alternate polarity. Their very high Curie point allows high speed / high temperature continuous operation.

The housing supports both induced and permanent magnet plates. The oversized fins efficiently evacuate the heat even in high ambient temperature for high reliability. The threaded design allows to easily tune the torque on-site for fine adjustment to the application.

The high quality bearings used allow to maintain constantly a very small airgap between the magnetic plates, allowing both high yield and no friction operation for very long lifetime.

Constant torque generation

The permanent magnets magnetize the induced plate, thus generating a ring of alternating polarity magnetic domains. The rotating magnetic field pulls the magnetic domains around the induced plate. The domains motion is constrained by the material hysteresis as if they were moving in a fluid.

This contactless interaction generates a very constant torque within a wide range of speed difference between input and output (300 to 3000rpm ca). This is a formidable advantage of CxW MAG Coupler vs torque motors, hydrodynamic couplers, friction clutches and competitors' magnetic couplers.

Operating Principle

• **Winding of cable**

The induced plate rotates at the speed of the electric motor. The permanent magnet is then driven by the magnetic forces and the spool will wind the cable at a rate that matches the speed of the mobile machine.

• **Unwinding of cable**

The induced plate always turns in the winding direction at the output speed of the electric motor. The permanent magnet which is connected to the spool shaft rotates in the opposite direction.

The electric motor always turns in the same direction regardless of the direction of the spool rotation.

• **Power off**

When the equipment is switched off, the rotation of the induced plate is stopped using a backstop bearing. The magnetic field of the permanent magnet generates torque, which prevents the cable from self-unwinding.

However, it is always possible to unwind the cable by applying a pull action stronger than the magnetic coupler torque.

Therefore, the cable (or hose) is protected even if the mobile machinery moves unintentionally (e.g. a crane pushed by the wind).

Settings

The amount of output torque generated by the coupler depends on the air gap between the induced plate and the permanent magnet. A smaller gap generates more torque, a larger gap generates less torque.

The air gap is factory pre-set for the application. However, adjustments can easily be made on-site if there are changes to the travel speed, cable, or hose.

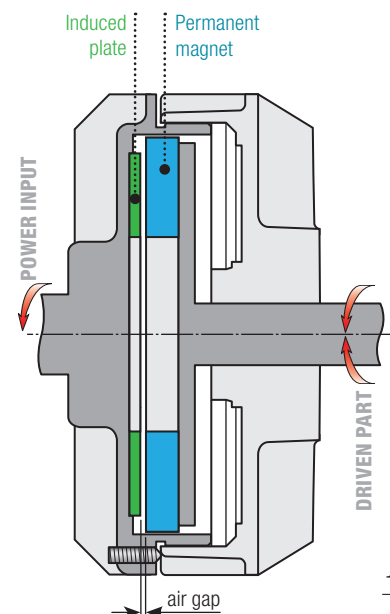



PELIGRO
ALTO
VOLTAGE

APL



MAERSK

MSC 928450
456

GENSTAR

GSTU 789617
4561

AHITAL

CLHU 888513
4561

GENSTAR 4561

Drives - Electronic | SMART Drive

VFD-ready motors and Conductix-Wampfler electronic control unit

Electronic Variable Frequency Drives (VFDs) for motorized cable reels are necessary for very high dynamics applications.

Our Active Control Units support accurate, permanent, on-the-fly adjustment of the torque applied on the spool.

Conductix-Wampfler carefully designs and adjusts its reeling systems to preserve and extend the lifetime of the cable. For our SMART Drive systems with Active Control Unit:



Conductix-Wampfler Electronic Control Units (SMART Drive)

1) **We define the optimal required torque curve** with the support of our reels design systems. This curve represents our knowledge and experience on how to best handle a reel through all the phases of the application's travel in order to minimize the pull on the cable.

2) **We implement a model-based predictive control** algorithm. This algorithm uses continuous inputs from the application and from the reeling system all along the travel length to anticipate the torque requirement. It provides a smooth and stable cable control.

3) **We offer a "Center Feed Crossing" option** to specifically handle this critical phase.

contain all this intelligence in a compact format with different physical options to make it easy to integrate in the application's E-Room, indoor or outdoor.

A SMART Drive reel with Active Control Unit can handle crane travel speeds up to 300 m/min and accelerations up to 0.6 m/s² *.

* depends on exact application parameters and reeling system options.

High Performance

Reducing wear on the cable is the permanent aim of Conductix-Wampfler high performance software.

For this purpose it constantly controls the Variable Frequency Drive to deliver the exact right amount of torque.

An Active SMART Drive reel will even allow a gantry crane to smoothly pass over the center-feed point at speeds up to 250 m/min. During the braking operation, our Active SMART Drive allows power recovery.

Conductix-Wampfler provides the best solution for each application. We start with the delivery of hardware components from reputable automation/electronics manufacturers (Siemens, ABB, TMEIC, Yaskawa, Emerson . . .) and software packages for the integration into the crane main control. We then add the complete switching cabinet including parametrized converters and appropriate control software. We finish by performing the final on-site commissioning.

Conductix-Wampfler's SMART Drive Reels communicate with the main control system of the crane via the established bus system or, for simple applications, by relay contacts.



Core Control Unit

Conductix Wampfler also offers a very efficient simplified and standardized control unit for slow applications (PCR < 50 m/min). It is a very compact outdoor unit equipped with Nord VFD controlling one winding torque and one unwinding torque with 24 V relay interface to sensors.

Cables

Specifying the right cable is a key part of the cable reel solution.

The correct cable influences cable reel performance and therefore the reliability of the complete system.

Conductix-Wampfler offers the most suitable cable for each application, operating speed, and environmental condition. We offer a complete range of cables from basic reeling cables to the highest premium quality cables to handle severe mechanical and dynamic demands.

Whether you need shielded or unshielded energy and control cables, data and bus cables, or fiber optic cables, Conductix-Wampfler has the right product for reeling applications!

Application													Extra Heavy Duty Reeling Systems		
	Basic Reeling Systems						Heavy Duty Reeling Systems								
Power / Control															
	MALT	GPM	RP	RG	WG	WGF	C800	GPM-RF	RXP	RXG	TRA	HVR	WXG	RXX	TRA-RF
Composite Power + Control + Data															
			RP-D	RG-D	WG-D	WGF-D			RXP-D	RXG-D		HVR-FO	WXG-D	RXX-D	
Label respectively Design	Conductix-Wampfler	Conductix-Wampfler	12YRDT11YH	NSHTOEJ-J	Conductix-Wampfler	(N)TSFLGGEW0EU	Conductix-Wampfler	Conductix-Wampfler	12YHRDT11YH	(N)SHTOEJ-J	Conductix-Wampfler	Conductix-Wampfler	(N)TSKCGEWEU	(N)SHTOEJ-J	Conductix-Wampfler
Outer jacket material	PVC	PUR	PUR	Rubber	Rubber	Rubber	PVC	PUR	PUR	Rubber	PUR	Rubber	Rubber	Rubber	PUR
Suitable for use outdoors	●	●	●	●	●	●	●	●	●	●	●	●	●	●	●
Voltage range	0.6/1 kV	0.6/1 kV	up to 0.6/1 kV	0.6/1 kV	3.6/6 kV up to 12/20 kV	3.6/6 kV up to 12/20 kV	0.6/1 kV	0.6/1 kV	up to 0.6/1 kV	0.6/1 kV	0.6/1 kV	3.6/6 kV up to 12/20 kV	3.6/6 kV up to 12/20 kV	0.6/1 kV	0.6/1 kV
Tensile load capacity max. [N / mm ²]	10	12	15	15	20	15	20	20	25	30	30	20	20	30+	30+
Travel speed max. [m / min]	40	60	80	120	120	120	60	60	180	240	200	180	300	240 *	240
Temperature range flexing [°C]	-20	-25	-20	-25	-25	-25	-10	-25	-40	-35 ⁽¹⁾	-25	-30 ⁽²⁾	-35	-35	-25
	up to 60	up to 60	up to 70	up to 80	up to 80	up to 80	up to 60	up to 60	up to 80	up to 60	up to 80	up to 80	up to 80	up to 80	up to 60

⁽¹⁾ -45 °C on request ⁽²⁾ -45 °C on request

* up to 300 m/min ● ideal ● limited

Reeling Cable Features

- Reduced diameter and weight by using ideal insulation and sheathing materials.
- Better resistance to corkscrewing* due to reverse twist stranding.
- Stable construction and geometry due to the use of extruded fillers.
- Highly wear-resistant outer sheath, even in aggressive environments.
- Extremely high resilience due to very short-lay stranding.

- High axial rigidity by means of interlinked inner and outer sheaths.
- All power cables are produced with left-hand lay.

- Cables built to withstand temperatures up to 180°C.
- Cables made to withstand especially demanding environments, water, waste waters, oil, and more.

Special Cables (available by request)

- Composite cables with power + control + fiber optics.
- Cables with compounds designed for temperatures down to -50°C.

Custom Cables

For unusual applications or environments, we can design a custom cable that meets your specific requirements. Contact us!

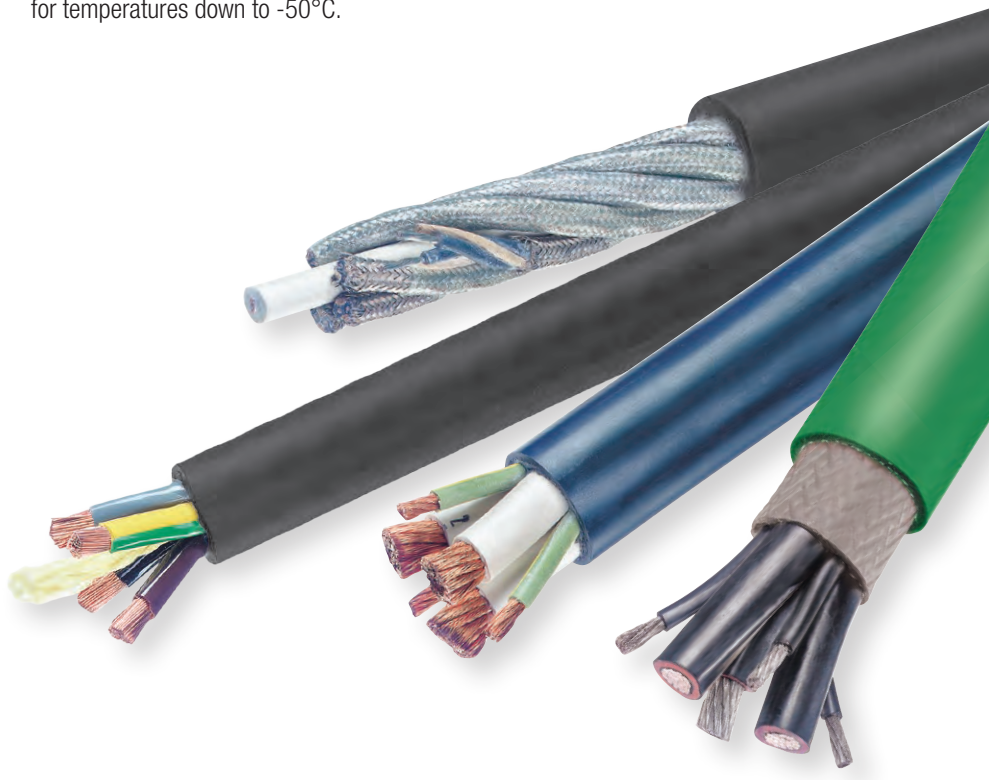

* Cables not designed for demanding reeling applications can become "corkscrewed" - that is, the internal conductors can become damaged.

Accessories

Conductix-Wampfler offers a complete range of accessories for motorized reels...

- 1 Connection boxes for power, control, and optic fiber
- 2 One-way or two-way cable guides with optional slack-cable, over-pull, and position detectors
- 3 Cable entries and anchor drums
- 4 Guiding and diverting devices
- 5 End limit switches
- 6 Anchoring device with shock absorber springs for vertical applications
- 7 On-ground "Angel-Wing" anchor drums
- 8 Strip heaters to reduce condensation in slip ring housings (not shown)

Many more accessories are available; contact us for details.

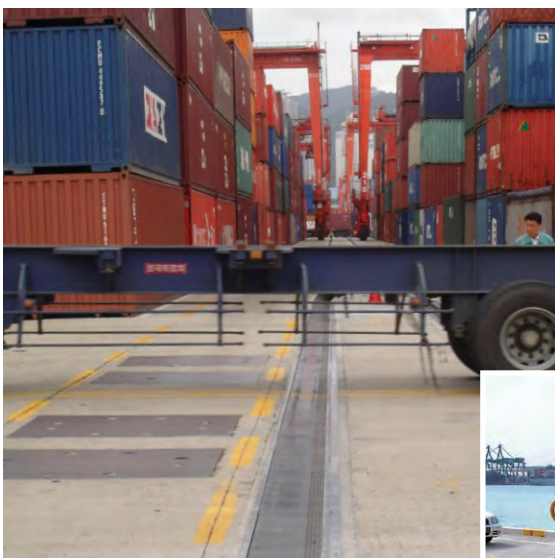
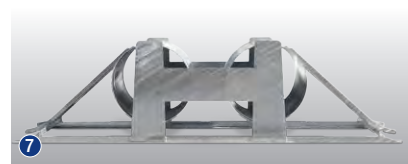

Trenchguard® Cable Protection System

The system includes:

- Galvanized or stainless steel pre-manufactured trench channel
- Reinforced flexible rubber belt
- Stainless steel mounting hardware
- Belt lifting rollers mounted on the cable guide



Application engineering



With decades of experience designing and engineering for specific applications, Conductix-Wampfler is uniquely capable of meeting the demands and requirements of your industry or environment.

Hazardous locations (ATEX), nuclear radiation, chemically aggressive environments, extreme climatic conditions, or saline air conditions are all available as optional protection packages.



ReelQuote



ReelQuote is a powerful software package for technical analysis of projects and selection of the best reeling solution. The program provides access to hundreds of optional features or application specific designs.

With ReelQuote, we guarantee you will get the best reel system for your application.



Customized Services

The scope and depth of the Conductix-Wampfler service range are based on the requests and requirements of our customers.

We can handle anything from project planning to long-term service agreements. For maximum operational life and the continued safety of complex systems, you should consider using our experienced service team.

At the planning stage we:

- Define the application parameters
- Select the most suitable motorized reel system and cable or hose
- Optimize the whole system to your requirements, application parameters, and environmental factors

At the pre-assembly stage we:

- Assemble the reel system
- Install the cable and connect the slip ring assembly
- Pre-adjust the parameters of the variable frequency drive units

At the final assembly and inspection stage we:

- Determine any additional assembly that needs to be performed on-site
- Complete the installation and commissioning using highly trained and experienced personnel
- Perform the final inspection
- Train and debrief the customers' personnel on-site

Maintenance and service

- Regular maintenance and inspections increase the operational life of the installation and ensure long-term performance and availability
- A Conductix-Wampfler service agreement is your "Worry Free Package"!



The experts at Conductix-Wampfler assist customers from planning through pre-assembly right up to the on-site installation - anywhere in the world



Your Applications – our Solutions

Motor driven reels from Conductix-Wampfler represent only one of the many solutions made possible by the broad spectrum of Conductix-Wampfler components for the transport of energy, data, gases, and fluids. The solutions we deliver for your applications are based on your specific requirements. In many cases, a combination of several different Conductix-Wampfler systems can prove advantageous. You can count on all of Conductix-Wampfler's Business Units for hands-on engineering support - coupled with the perfect solution to meet your energy management and control needs.



Festoon systems

It's hard to imagine Conductix-Wampfler cable trolleys not being used in virtually every industrial application. They're reliable and robust and available in an enormous variety of dimensions and designs.

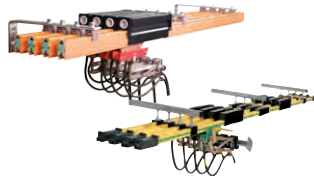

Conductor rails

Whether they're enclosed conductor rails or expandable single-pole systems, the proven conductor rails by Conductix-Wampfler reliably move people and material.

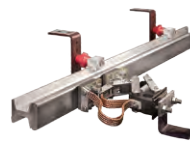

Non-insulated conductor rails

Extremely robust, non-insulated conductor rails with copper heads or stainless steel surfaces provide the ideal basis for rough applications, for example in steel mills or shipyards.



Slip ring assemblies

Whenever things are really "moving in circles", the proven slip ring assemblies by Conductix-Wampfler ensure the flawless transfer of energy and data. Here, everything revolves around flexibility and reliability!



Motorized Cable & Hose Reels

Motorized reels by Conductix-Wampfler hold their own wherever energy, data, media and fluids have to cover the most diverse distances within a short amount of time – in all directions, fast and safe.



Spring Cable & Hose Reels

With their robust and efficient design Spring Cable and Hose Reels from Conductix-Wampfler are unbeatably reliable in supplying energy, signals, data and fluids to a vast range of tools, cranes and vehicles.



Inductive Power Transfer IPT®

The no-contact system for transferring energy and data. For all tasks that depend on high speeds and absolute resistance to wear.



Retractors and Balancers

Our wide range of high reliable retractors and balancers remove the load from your shoulders and allow you to reach top productivity.



Energy guiding chains

The "Jack of all trades" when it comes to transferring energy, data, air and fluid hoses. With their wide range, these energy guiding chains are the ideal solution for many industrial applications.



Jib booms

Complete with tool transporters, reels, or an entire media supply system – here, safety and flexibility are key to the completion of difficult tasks.

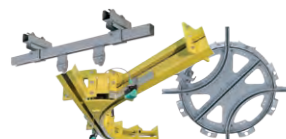

Conveyor systems

Whether manual, semiautomatic or with Power & Free – flexibility is achieved with full customization concerning layout and location.

www.conductix.com

Conductix-Wampfler
has just one critical mission:
To provide you with energy and
data transmission systems that
will keep your operations up
and running 24/7/365.

To contact your nearest
sales office, please refer to:

[www.conductix.com/
contact-search](http://www.conductix.com/contact-search)



DELACHAUX GROUP