

For further information please contact  
bertrand.fonteneau@conductix.com

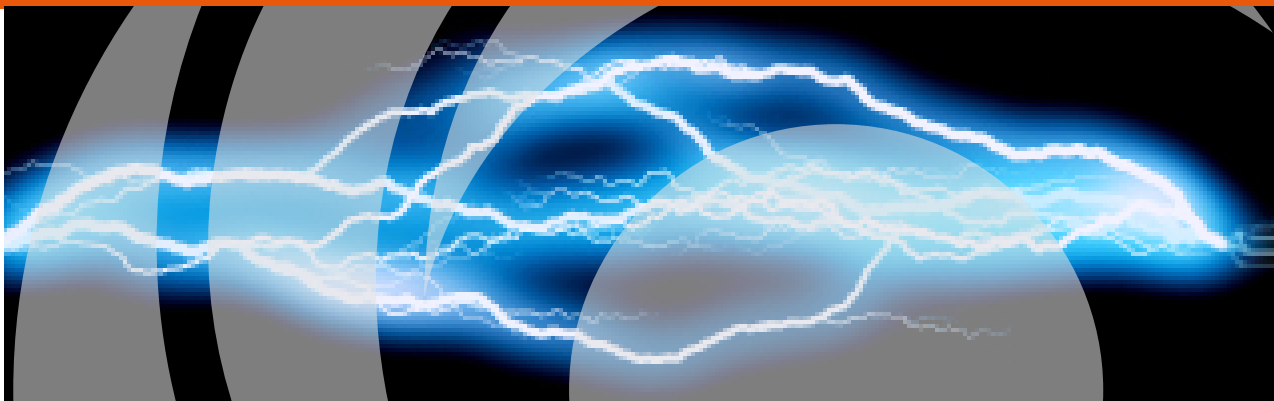

© Conductix-Wampfler | White Paper | WP2024/02-EN

## High-Voltage Corona Effect | General Points Application to Metal-Enclosed High-Voltage Collections



The so-called corona effect is famously manifested in a form known since ancient times: St. Elmo's Fire. This singular effect appears for instance in the form of glowing lights on the tops of ships' masts in stormy conditions.

This phenomenon of partial electrical discharge caused by the ionisation of the surroundings of a conductor appears when the electric field exceeds a critical value  $E_c$  (but where its conditions do not enable arc formation). It is manifested by the appearance of bluish or violetish light spots (on some rough metallic surfaces), light lines or occasionally an elongated „light sheath“ which forms around cables carrying a high-voltage current. It also causes crackling, radio-electric interference, energy loss or pollutant emissions

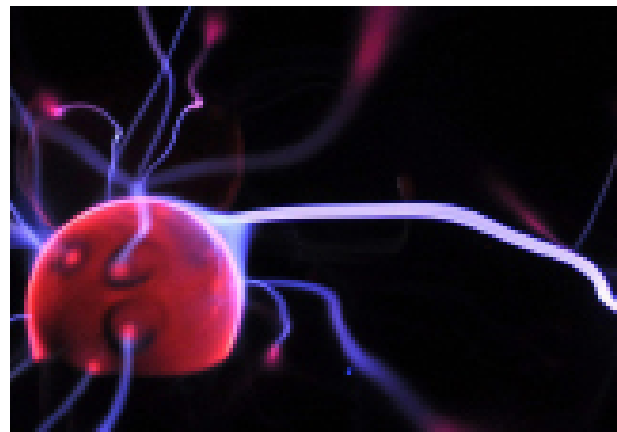

## Application to metal-enclosed high-voltage collectors

### The most common causal factors of a corona effect

- Lugs incorrectly crimped. This produces an arcing phenomenon, which is more acute on the angular parts.
- Conductor incorrectly inserted into the lug, leaving some copper wires exposed
- Dirt, contamination and damage on the conductors. This leads to brush discharges forming due to the point effect
- Defect on the semi-conductor terminal screen (point – air inclusion – notch in the insulation). This type of defect could be detected by a partial discharge measurement test.
- Poor insulation on the lug: leads to brush discharges forming due to the point effect. These areas must be covered with insulating tape.

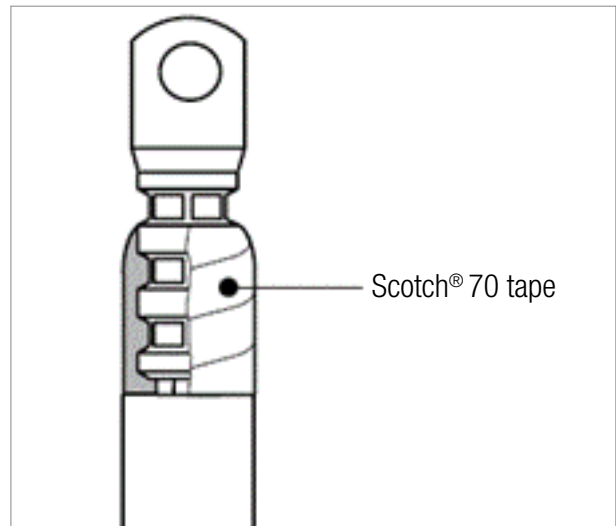
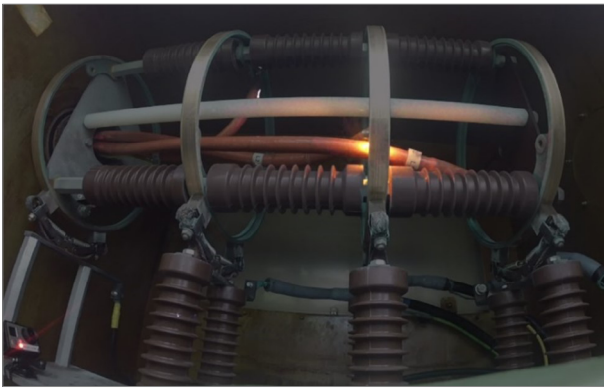

**Effects:**

- Acrid smell in the enclosure due to the presence of ozone
- The various compounds (ozone, nitrous derivatives, acidic gases, ammonia derivatives) formed during corona effect discharges cause:

Oxidation of parts containing copper:

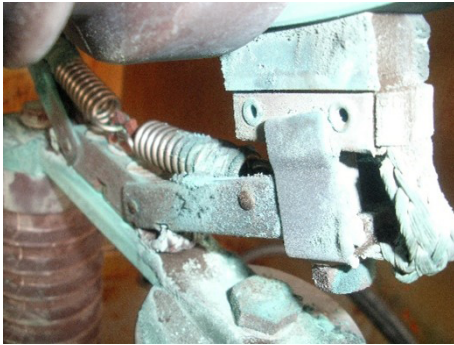

Oxidation of steel parts (formation of iron oxide):



Whitish deposits:

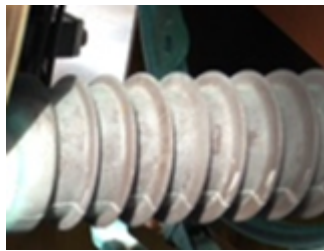

Accelerated deterioration of some materials, including rubber (silent block, seal...):



Brownish streaks:



Longer-term deterioration of the insulation:

This is initially manifested by discolouration primarily affecting the insulation. This is the material undergoing chemical transformation caused by the decomposition products created by the electrical discharge (mainly ozone). The dielectric characteristics of the insulation are degraded.

When the phenomenon develops further, the insulation is rotted by actual branching cracks, most often accompanied by small pockets in which black marks (carbon) can be found, due to burning.

The surface resistivity of the insulation is reduced, enabling significant leakage currents to appear, thereby impairing the collector's electrical performance.

### Recommendations:

- Make sure to properly tighten the electrical connections (adhering to the tightening torque)
- Meticulously install the cable heads as per the kit suppliers' recommendations
- Select suitable cable heads for the application (in particular suited to operating in wet environments)
- Use a heating resistor to prevent any condensation phenomena. The resistors fitted on our devices are auto-regulated or thermostat regulated. So they must have a constant power supply
- Do not use ozone-sensitive materials such as rubber
- If in doubt, or for monitoring purposes, use detection systems such as corona cameras or ultrasonic detection devices to detect crack initiation.

**Optionally, Conductix Wampfler can on request equip this equipment with these kinds of monitoring devices**

## Corona effect: further technical info

### Presentation of the phenomenon

The corona discharge is a non-homogeneous discharge, generated between an electrode with a small bend radius (point or a thin wire) and an electrode with a large bend radius. During the discharge, the electrode with the small bend radius subjected to a high voltage is the centre of a strong electric field causing ionisation of the neutral species present in the gas.

The theoretical critical field  $E_c$  is given by Peek's formula. This is the value from which the corona effect forms around a perfectly smooth cylindrical conductor, according to its radius:

$$E_c = E_p \cdot m \cdot \delta \cdot \left( 1 + \frac{K}{\sqrt{\delta r_0}} \right)$$

Where:

- $E_c$ : critical field in kV/cm
- $E_p$ : reference field -  $E_p = 31$  kV/cm
- $m$ : factor depending on the surface condition of the electrode ( $m=1$  for a well-polished electrode)
- $K$ : constant equal to 0.308
- $r_0$ : conductor radius in cm
- $\delta$ : relative density of air, where:

$$\delta = \frac{3.92P}{273 + T}$$

- o  $\delta = 1$  at  $P=76$  cm Hg and  $T = 25^\circ\text{C}$
- o  $T$ : temperature in  $^\circ\text{C}$
- o  $P$ : air pressure in cm Hg

Peek's formula remains valid for frequencies ranging from 25 to 120 Hz,  $V/V_0$  values of more than 1.8 and conductors with a radius of more than 2.5 mm, where:

- $V$ : phase-neutral voltage
- $V_0$ : critical voltage



So we can see that this field will be influenced by various parameters:

- Conductor surface roughness (dust, damage to conductor, surface condition): they lower the critical field value (point effect)
- Conductor dimensions: the greater a conductor's diameter, the more the critical field decreases
- The presence of water droplets on the conductor plays the same role as surface roughness:

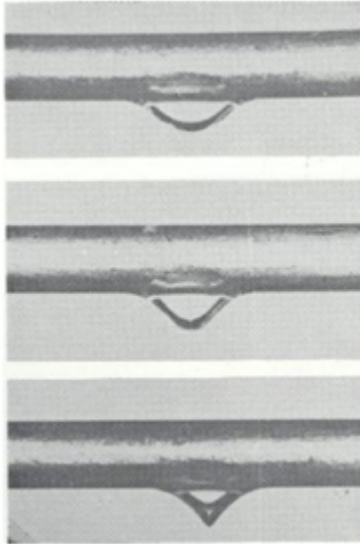

*Water droplet geometry altered under the effect of an electric field, giving it a very small bend radius, i.e. locally reducing the critical field (point effect)*

- Air pressure: when the pressure drops, the critical field decreases
- Air temperature: when the temperature increases, the critical field decreases
- Air impurities (water vapour (moisture), solid particles, etc.): these impurities, and mainly moisture, contribute to reducing the critical field

Under normal conditions, the air around electrical conductors always contains ionised particles (due to cosmic radiation, UV rays, the Earth's radioactivity, etc.). If an electric conductor is subjected to an AC voltage, a potential gradient is instantly created around its surface. The free electrons initially present in this region of space will be accelerated under the effect of the electric field: the electrons are accelerated toward the conductor surface in the positive half-period, and away from the conductor surface in the negative half-period. The greater the potential, the greater the acceleration of these electrons.

When the potential gradient on the conductor surface reaches a certain value, the velocity acquired by the free electrons is sufficient to strike a neutral molecule with sufficient force to dislodge one or more of its electrons. This produces another ion, and one or more free electron(s), which are in turn accelerated until they collide with other neutral molecules, producing further ions. Hence the ionisation process is cumulative.

This acceleration, collision and cumulative process phenomenon also exists in DC voltage.

So corona discharges generally occur between an electrode with a small bend radius (e.g. conductor defect forming a point), with the result that the electric field in its surroundings is strong enough to enable plasma formation, and another with a large bend radius (a metal plate or the Earth).

If the geometry of the conductor and field value are such that the ionised region extends instead of stabilising, the current can end up finding a way to the opposite electrode. This produces sparks or an electric arc.

## Effects

The Corona effect degrades installations and their environment. It has multiple effects:

### Pollutant emissions

Corona effect discharges cause the formation of:

- Ozone:  $O_3$
- Nitrous derivatives:  $NO_x$
- Acidic gases:  $HNO_2$ ,  $HNO_3$  (Saltpetre, a white powder which is a salt of nitric acid)
- Ammonia derivatives:  $NH_4$ ,  $NO_3$

There are multiple chemical reactions, which can be summarised as follows:

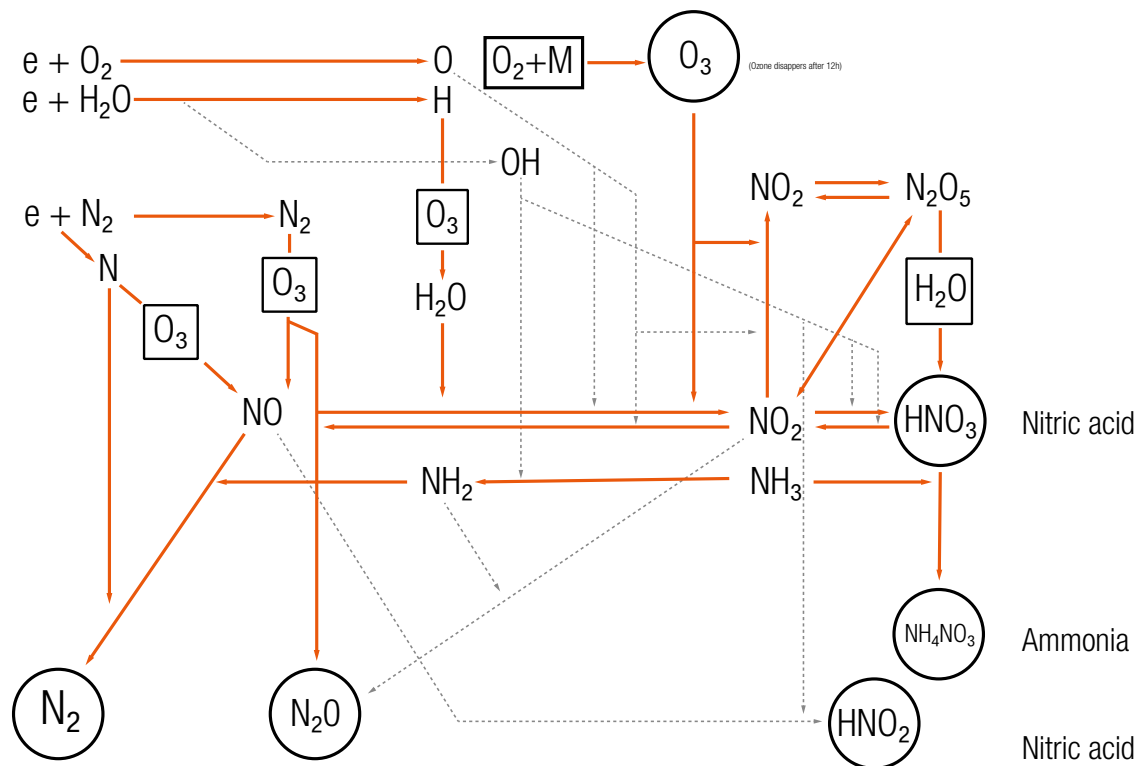

These products will themselves react with the materials present:

E.g. with copper or copper alloys (brass-bronze):

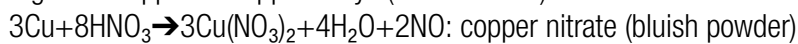

E.g. with steel:

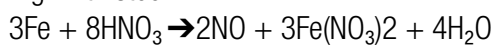

These corrosive elements may also damage the insulant and end up causing an insulation defect.

In particular, ozone attacks certain materials:

- Materials **not** resistant to ozone
  - Polypropylene
  - Steel, zinc, iron, copper and other oxidisable metals
  - Nylon
  - Magnesium
  - Rubber
  - Neoprene
  - Polyamide

*Rubber silent block damaged by ozone:*

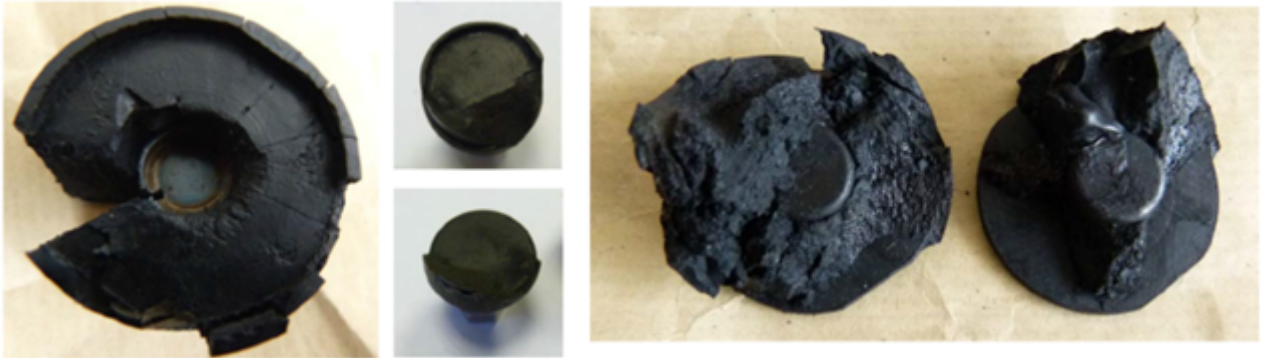

- Materials resistant to ozone in the gaseous phase:
  - Glass
  - Teflon (PTFE, PVDF, PFA)
  - 316L stainless steels
  - Silicone
  - Titanium
  - Polyurethane
  - Polycarbonate
  - Kynar, Viton, etc.

Unlike odourless dioxygen, ozone is perceptible to the human sense of smell (detectable from a concentration of 0.01 ppm). Its characteristic odour, reminiscent of bleach, is perceptible in confined spaces containing a strong electric field (high-voltage transformer, arc welding, UV tubes, piezo-electric spark lighter). When inhaled in large quantities, it is toxic, causing coughing



### Crackling:

The noise is manifested in the form of crackling, rattling or whistling. This phenomenon creates pure low-frequency tones (humming), primarily between 120 and 240 Hz, which are caused by movement of the charge surrounding the conductor.

### Radio-electric interference:

The corona effect produces current and voltage pulses on line conductors. The frequency spectrum of these pulses is so big that it can include a large part of the radio frequency band, extending from 3 kHz to 30,000 MHz.

These pulses increase in wet weather, and may cause interference with telecommunication systems.

### Energy losses:

The phenomenon is accompanied by a generally negligible energy loss in dry weather, but this can become considerable in the presence of moisture.

### Light emissions:

The corona effect generates light radiation. This phenomenon appears mainly in the ultraviolet light region, which is invisible to the naked eye. However, a small part of the emissions is visible at night, appearing in the form of small blueish flames on protruding metal parts.

The corona effects is a capacitive defect which does not cause heating. **It cannot be detected by infrared thermal imaging.**

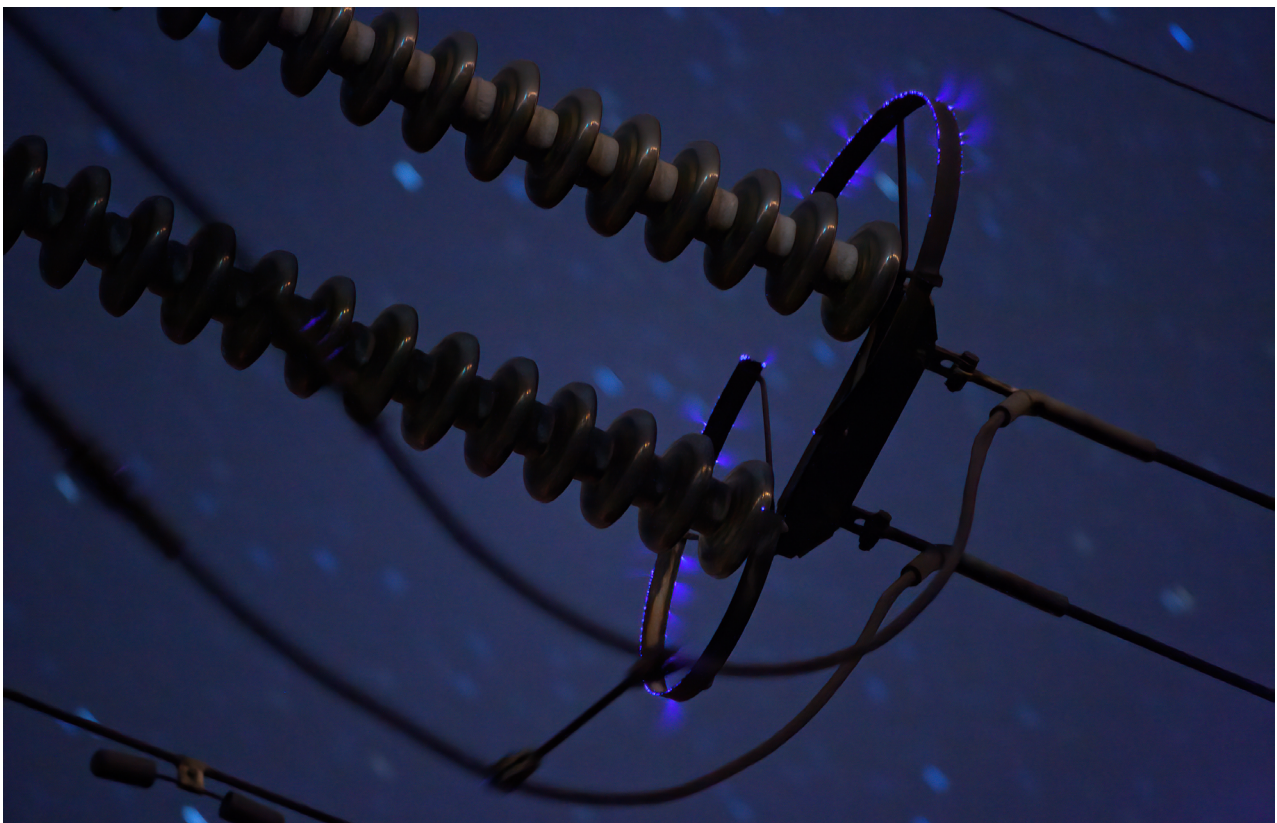

## Causes

There are numerous factors that can cause or increase corona discharges, e.g.:

- Cracked or extremely dirty insulation
- Damaged conductors
- Rusted fittings
- Points or sharp edges on a conductor
- Incorrectly tightened connections
- Cable heads with unprotected sharp edges

Moisture is an aggravating factor, but is not in itself the cause.

## Detection

The corona effect indicates faulty design and/or installation. The appearance of the phenomenon indicates that the degradation processes are under way, acting as a warning.

In some cases, incorrect installation may be revealed by a partial discharge test (standardised test).

These partial discharges, due to their capacitive and non-resistive nature, do not generate heat, and are therefore not observable by thermal imaging.

There are various detection systems:

- Specific cameras operating in the UV region, known as corona cameras, can be used to clear up any doubts, or for monitoring purposes. They are able to detect and locate defects in high-voltage electrical structures.

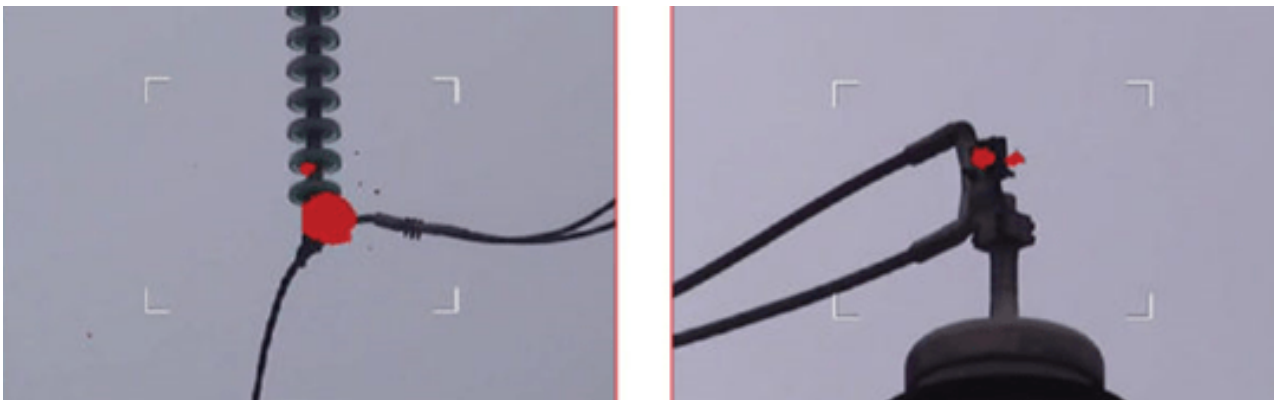

Corona effect discharges generate electromagnetic radiation between 230 nm and 405 nm. This spectral band covers some of the UV region, as well as the visible region.

## Spectral Irradiance of Corona and Solar Energy

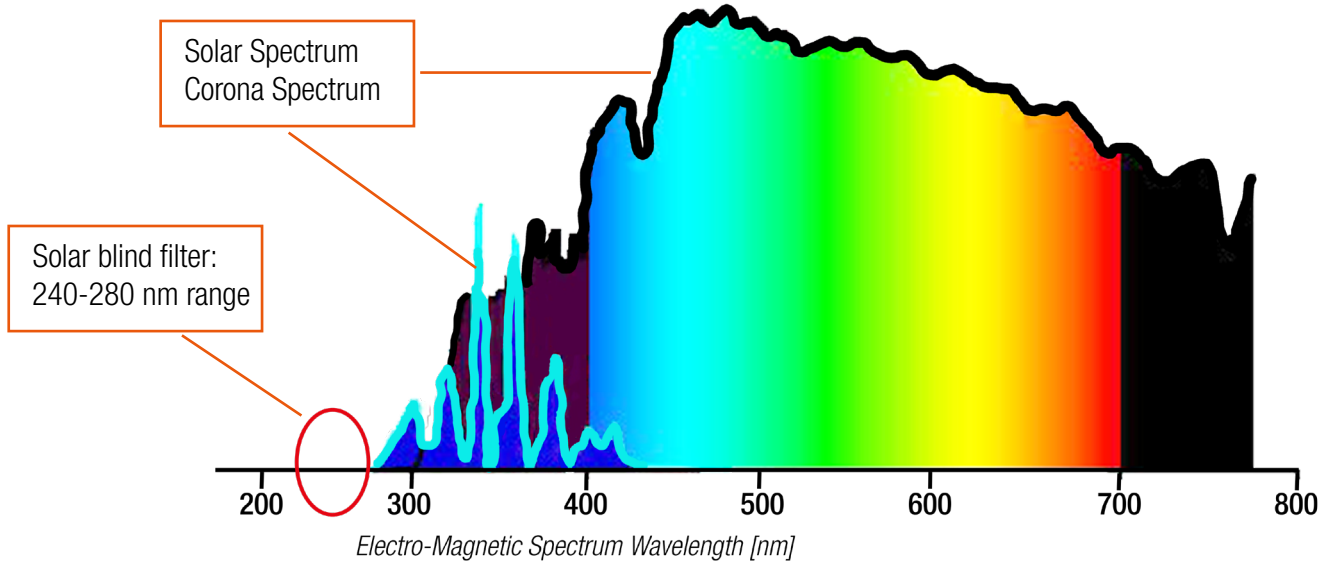

*| Superimposed electromagnetic spectra from the corona effect and the sun*

A simple filter only letting through these wavelengths should make it possible to observe these corona effects. However, the energy produced by sun during the day in the UV spectrum is much greater (by a factor of around 1000), which affects the observability.

The process used on these cameras consists in reducing the filter bandwidth to 280 nm, to only allow through the UV A and UV B region wavelengths. The UV C radiation produced by the sun will be fully absorbed by the ozone layer in the atmosphere. In summary: the corona effect produces radiation between 230 and 405 nm, but it is observed only in the UV C band, i.e. between 230 and 280 nm.

- Ultrasonic detection: since losses due to the corona cause sonic and ultrasonic interference, sensors can be used to precisely locate and identify them.

These devices are used to detect the presence of ultrasonic or acoustic impact signals. For the applications that concern us here, the quantity of ultrasound generated in the air during a discharge is tiny and short-lived, and requires specific devices.

These devices often have a piezo-ceramic ultrasonic sensor, with an amplification cone increasing its sensitivity. The piezo-electric property of ceramic is used to generate an electric pulse measurable under the action of a mechanical stress, namely acoustic pressure. The signal is then amplified.

## The author

### Bertrand Fonteneau

Responsable BE Standardisation | Product & Processes Development / Engineering  
Conductix-Wampfler SAS

## Bibliography

- Sébastien DUFOUR – Marc-Antoine DUFOUR: „Utilisation de l’effet Corona dans la cadre de la surveillance et de la maintenance préventive des réseaux HTB (Transport d’Electricité)“ [Use of the corona effect for monitoring and preventive maintenance of high-voltage networks (Electricity transport)] – Internship report at RTE – 2010
- Etienne OUSS – „Caractérisation des décharges partielles et identification des défauts dans les PSEM sous haute tension continue“ [Characterising partial discharges and identifying defects in metal-enclosed switch gear under AC high voltage] - University of Lyon doctoral thesis – 2018
- Sabrina ABDALI – Cherif AIANE – „L’effet de la température sur les paramètres de la décharge couronne“ [The effect of temperature on corona discharge parameters] - Final dissertation – Abderrahmane Mira-Bejja University
- M BURNICHON - NORISKO – „Expertise suite à incident sur enrouleur“ [Assessment following an incident on a reel] - 2008
- Houria KHALFOUNE – Maxime GENESTOUX – „Study of the damage of elastomer blocks“ - LRCCP assessment report - 2011
- Betiac – „L’ingénierie au service du développement:“ [Engineering at the service of development] <https://betiac.ma/effet-corona>
- Synergys Technologies - <https://www.synergys-technologies.com/inspection-uv-ht/>
- AMPERIS – Corona effects detection camera – <https://amperis.com/en/resources/articles/corona-effect-camera-energy-industry/>  
<https://amperis.com/en/resources/articles/types-partial-discharges/>
- NDBtech – Ultrasonic corona effect detector - <https://www.ndbtech.com/products/uld-40/>
- Conductix-Wampfler photo library | Adobe Stock

